

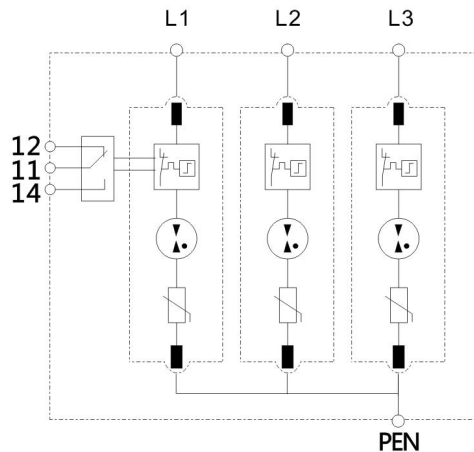

Outside drawing

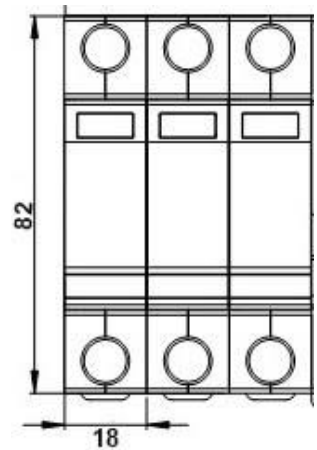

Electrical principle



Outline dimension

Type 2 lightning and surge protective device especially for low-voltage power supply system surge protection at the boundaries from lightning protection zone 1-3 and higher.

- Class II/class C SPD, max discharge current 40kA 8/20
- Pluggable design surge arrester for easy replacement
- VT technology surge protector, with very low clamping level compare to MOV technology
- High TOV withstand, increased reliability for areas with unstable power network
- **No follow current and no leakage current**, intelligent distinguish power frequency current and surge current to guarantee long service life

Part No.	SP40-275VT/3P-FS	
In accordance with	IEC61643-11:2011; UL1449 4th	
Category IEC/VDE	II/C	
Max. continuous operating voltage (AC/DC) U _c	275/350	
Nominal discharge current(8/20) I _n	20kA	
Max. discharge current(8/20) I _{max}	40kA	
Voltage protection level/U _p @I _n	<2.0kV	
Response time	≤100 ns	
Follow current& Leakage current	No	
Backup fuse(only required if not already provided in mains)	125A gL/gG	
Temporary Overvoltage TOV-Withstand mode	700V/120min	
Operating temperature range	- 40°C ~ + 80°C	
Cross-section of connection wire	Single-strand 35mm ² ; multi-strand 25mm ²	
Torque applied by the screws	2.0-2.5 Nm	
Mounting	35mm DIN-rail in accordance with EN 50022/DIN46277-3	
Enclosure material	thermoplastic; extinguishing degree UL94 V-0	
Degree of protection	IP20	
Installation width	3 modules, DIN 43880	
Thermal disconnecter	Internal green – normal ; red - failure	
Remote alarm contact	Yes	
Additional data for Remote Alarm Contacts	Closed and open 1.5mm ² / 0.5 Nm ,max	
Remote alarm contact type	Isolated Form C	
Switching capability Un/In	AC: 250V/0.5A DC: 250V/0.1A; 125V/0.2A; 75V/0.5A	
Max. Size of connecting wire	Max. 1.5mm ² (or # 16AWG)	